

## PoINT Archival Gateway

### S3 Gateway for Tape

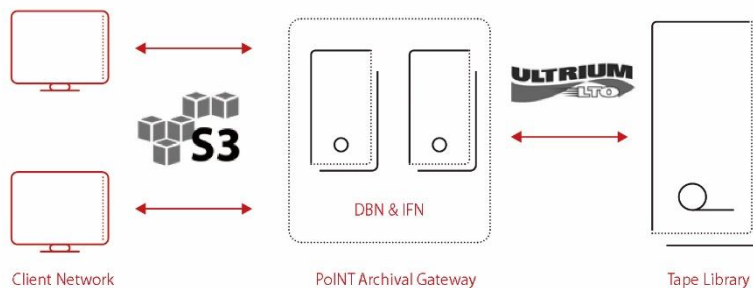

### Solution Overview

# PoINT Archival Gateway

## Configuration Overview

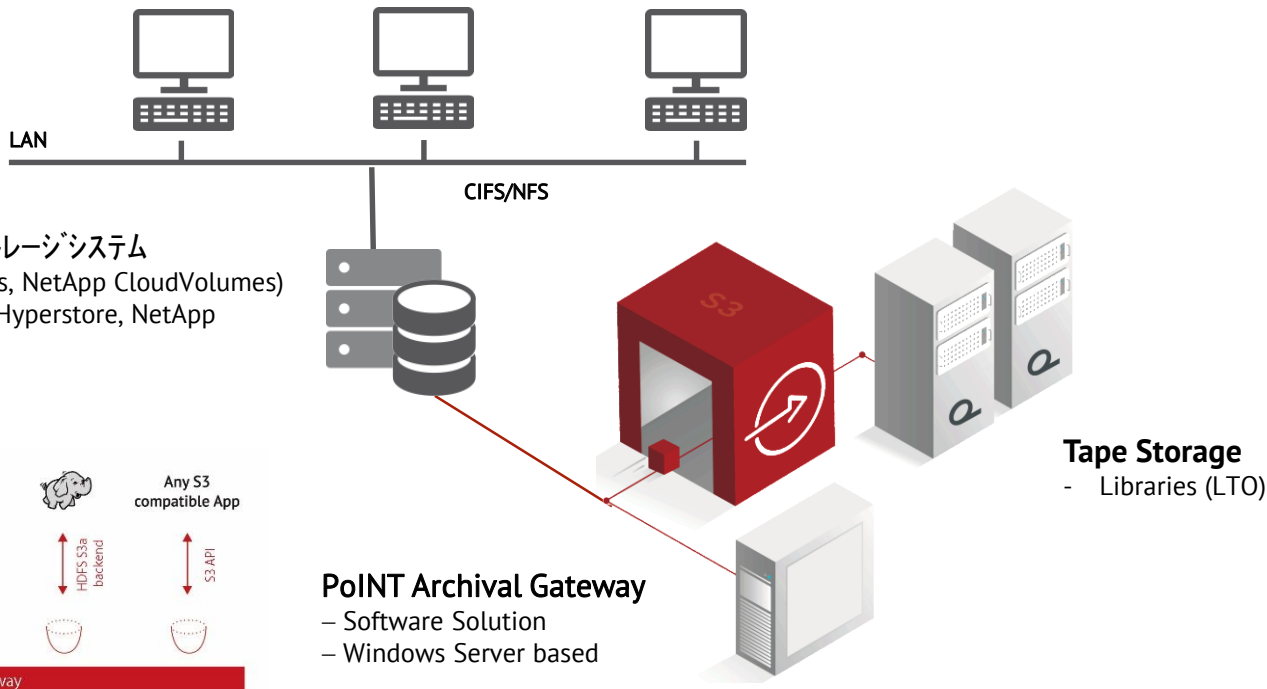

# PoINT Archival Gateway

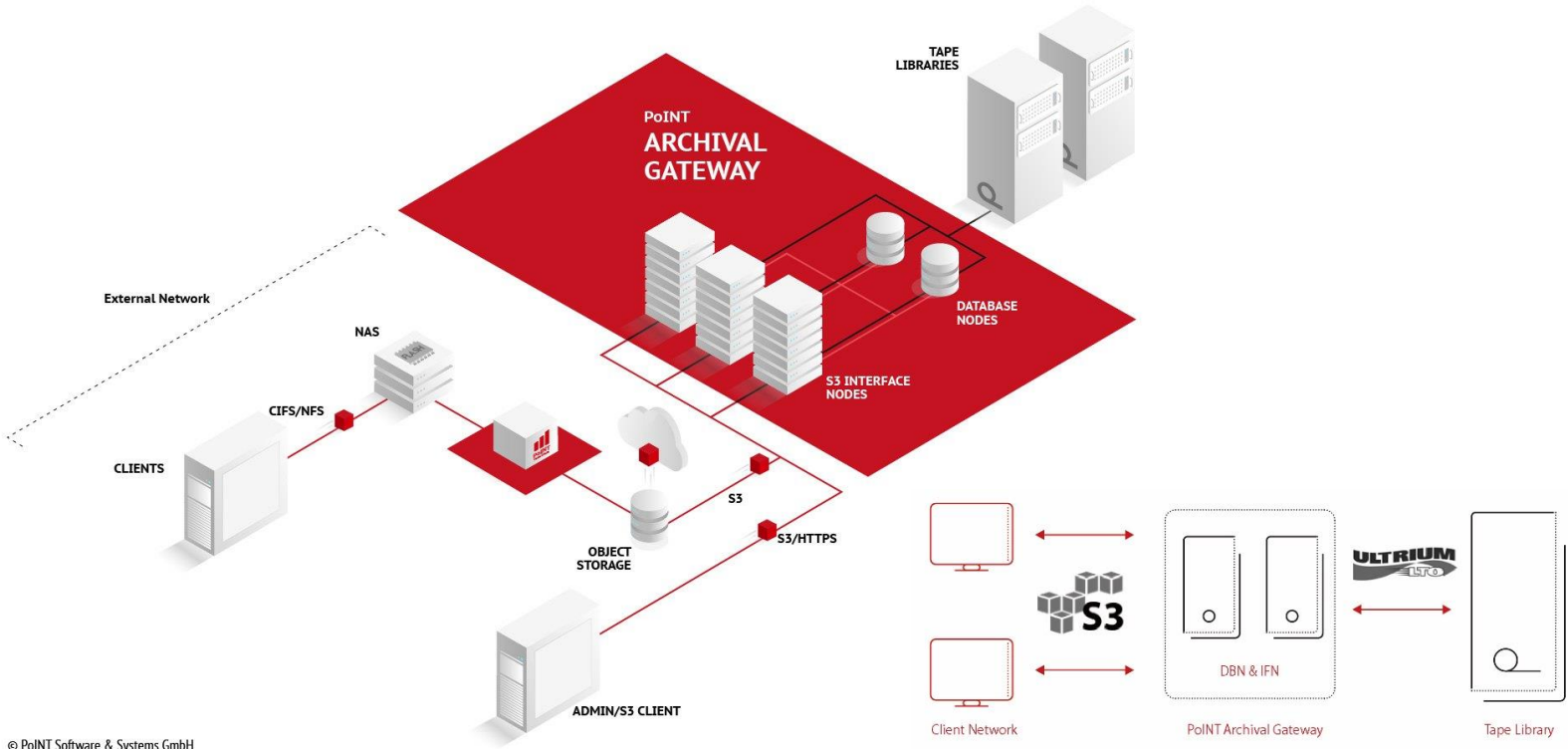

© PoINT Software & Systems GmbH

# PoINT Archival Gateway

## Configuration Overview 2 NetApp

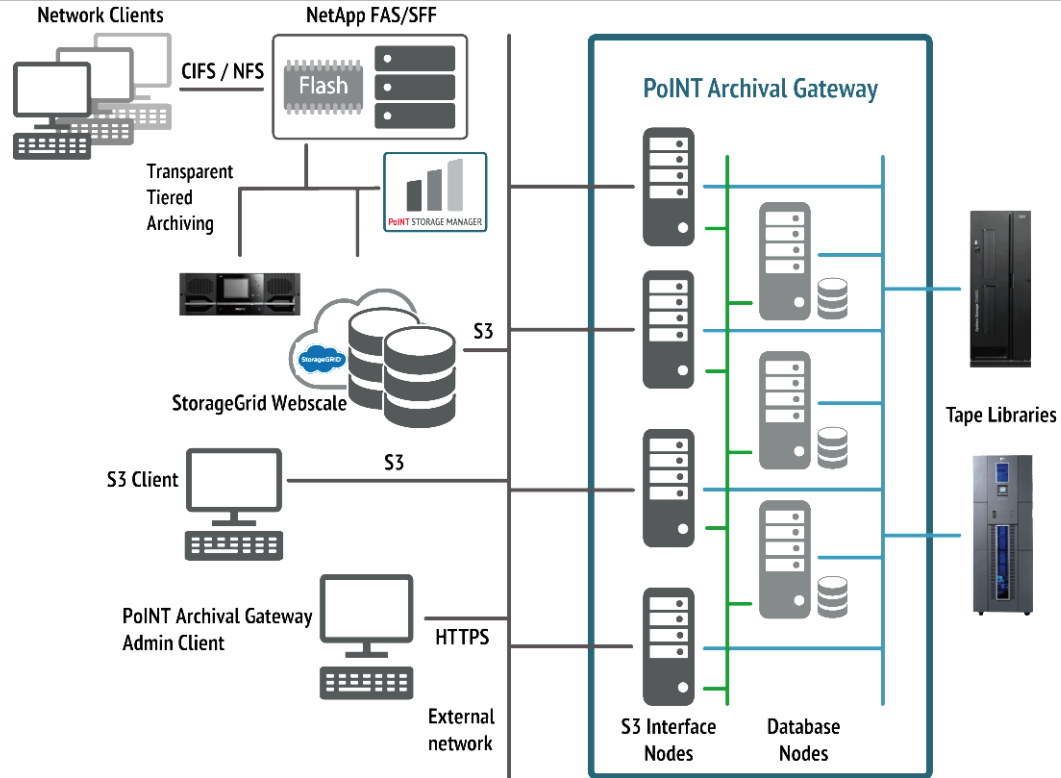

# PoINT Archival Gateway

## Conceptual Overview(NetApp)

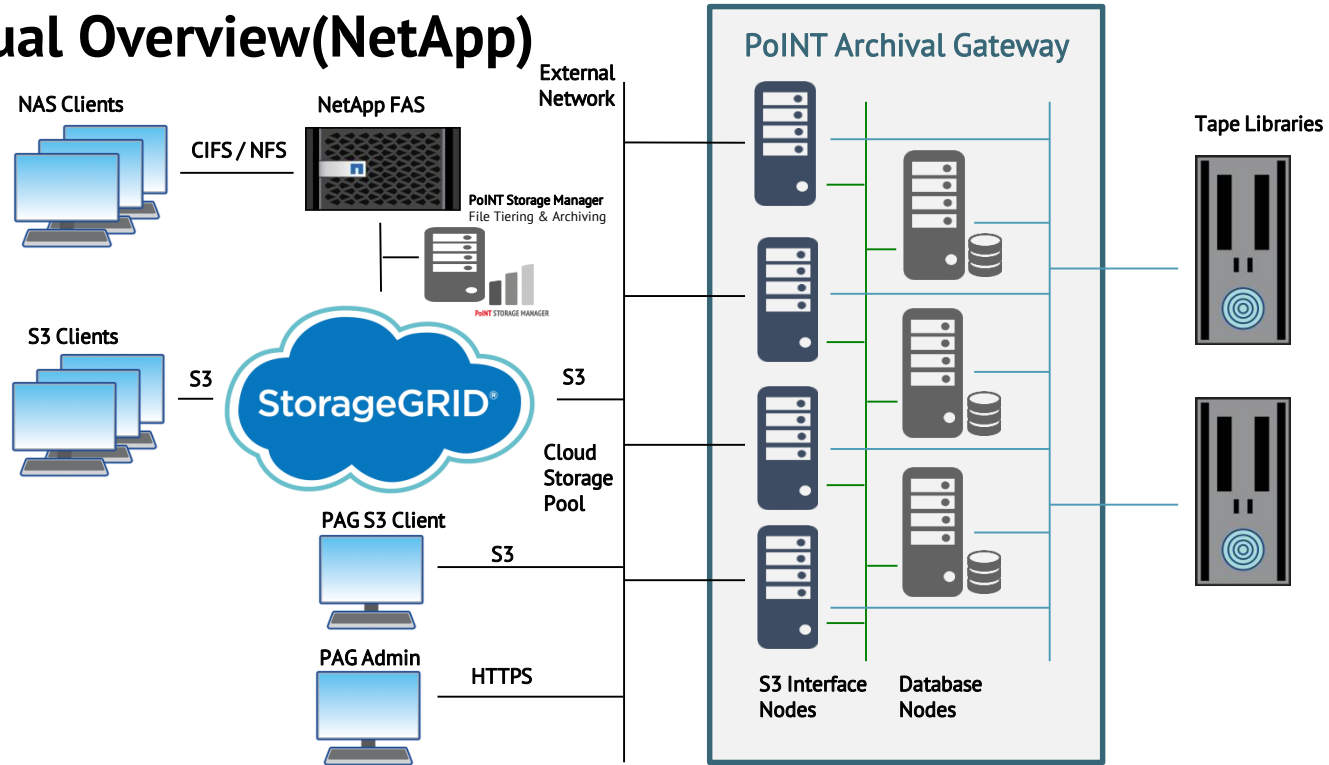

# PoINT Archival Gateway

## Conceptual Overview

NetApp StorageGrid



Cloud Storage Pool

External Network

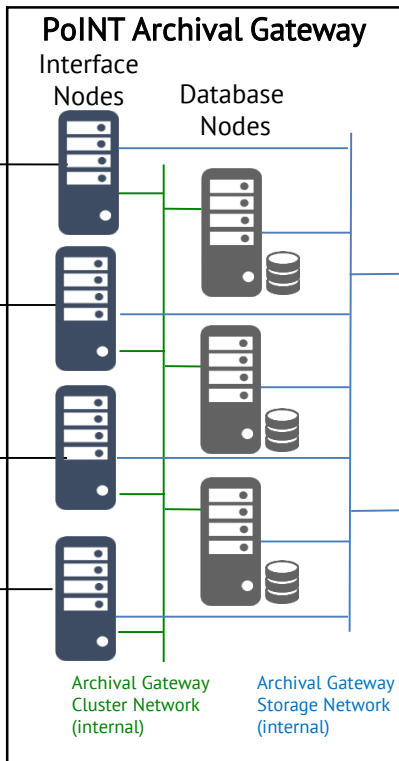

Tape Libraries



## Interface Node

- Webサービス機能 (i.e. S3 REST API, Load Balancer)
- AWS S3 MPU(Multi-Part-Upload)にスケーラブルに対応
- データキャッシュ機能 (i.e. リードと先読みキャッシュ)
- データエンコード機能 (イレージャーコーディング, Hash演算, 暗号化)
- ドライブ管理機能 (LTOドライブを直接制御 read/write)
- メタデータキャッシュ機能 (e.g. object metadataの先読み)
- データベースノードとの通信機能 (メタデータの共有)
- MultiPart Uploadの要件に応じてクラスター構成が可能

## Database Node

- データベース管理機能
  - オブジェクトとメタデータのサービス
  - 動作設定のデータベース
  - Includes synchronous replication, backup and caching
- ライブラリー管理機能
  - ライブラリーのメディア移動の管理
- システム動作の監視と管理
- システム動作設定の管理(管理用Webサーバー)

# PoINT Archival Gateway

Interfaceノードとdatabaseノードはサービスとして稼動します。最小構成として、1台のサーバーで1つのサービスとして稼動します。

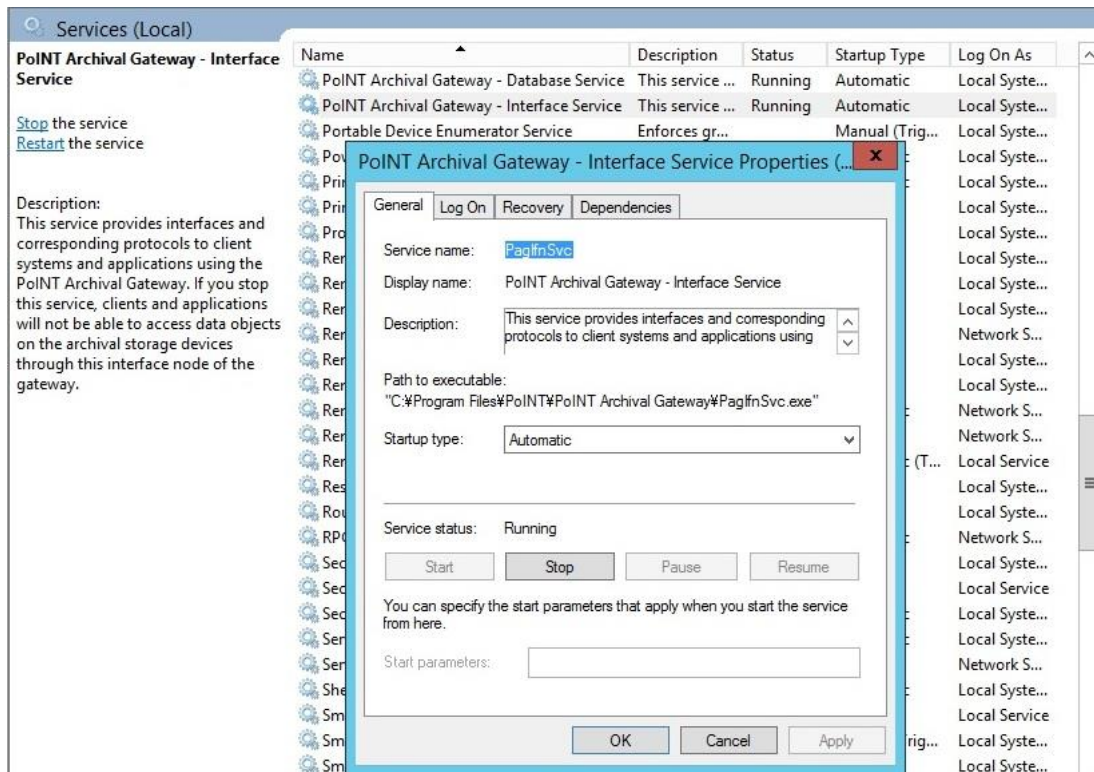

## 管理Webのスクリーンショット

管理WebはIISのアプリケーションとして稼働します。

System Cluster Nodes

Database Nodes

Name	Role	Address	Status	Logs	Statistics	Remove
DBN 1	Active	192.168.1.230:4000	Up			

Interface Nodes

Name	Role	Address	Status	Logs	Statistics	Remove
IFN 1	Active	192.168.1.230:4000	Up			

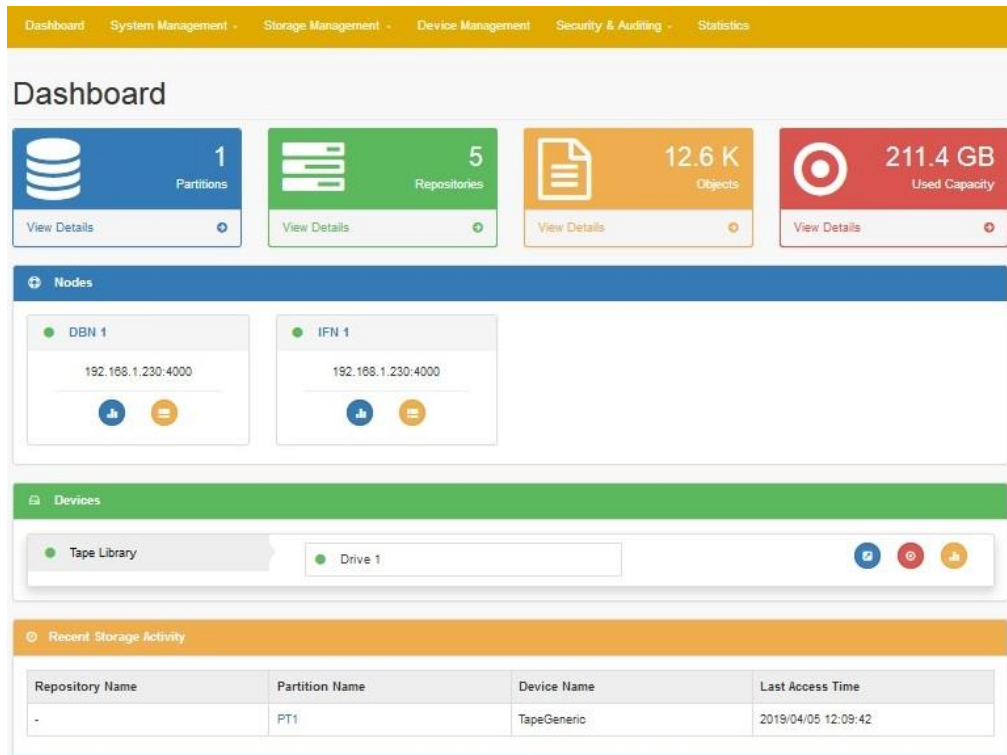

Dashboard

- Partitions: 1
- Repositories: 5
- Objects: 12.6 K
- Used Capacity: 211.4 GB

Nodes

- DBN 1: 192.168.1.230:4000
- IFN 1: 192.168.1.230:4000

Devices

- Tape Library
- Drive 1

Recent Storage Activity

Repository Name	Partition Name	Device Name	Last Access Time
-	PT1	TapeGeneric	2019/04/05 12:09:42



管理Webのスクリーンショット  
2つのノードを統合して稼動した場合の例

The screenshot displays the PoINT Archival Gateway management web interface. At the top, there is a navigation bar with the PoINT logo and user options: 'Change password for admin', '7:57', and 'Log off'. Below the navigation bar is a yellow header with menu items: 'Dashboard', 'System Management', 'Storage Management', 'Device Management', 'Security & Auditing', and 'Statistics'. The main content area is titled 'Dashboard' and features four blue cards with icons and data: '1 Partitions', '3 Repositories', '179 Objects', and '16.65 GB Used Capacity'. Below the dashboard is a 'Nodes' section with a yellow header, containing a card for 'CGN 1' with IP address '0.0.0.0:4000'. At the bottom is a 'Devices' section with a yellow header, showing 'Virtual Media Changer', 'Drive 1', and 'Drive 3'.

# PoINT Archival Gateway

管理WebはIISのアプリケーションとして稼動します。

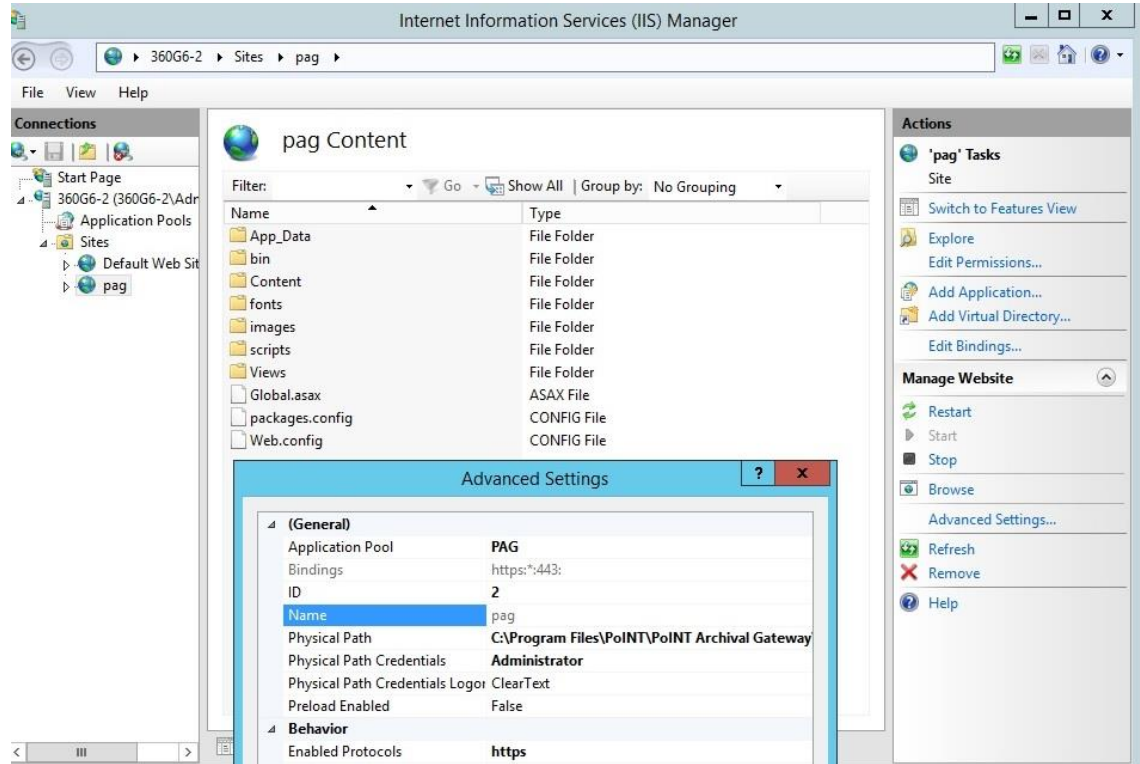

## S3クライアントからPAG/INTノードへの接続 S3 Browserでの接続

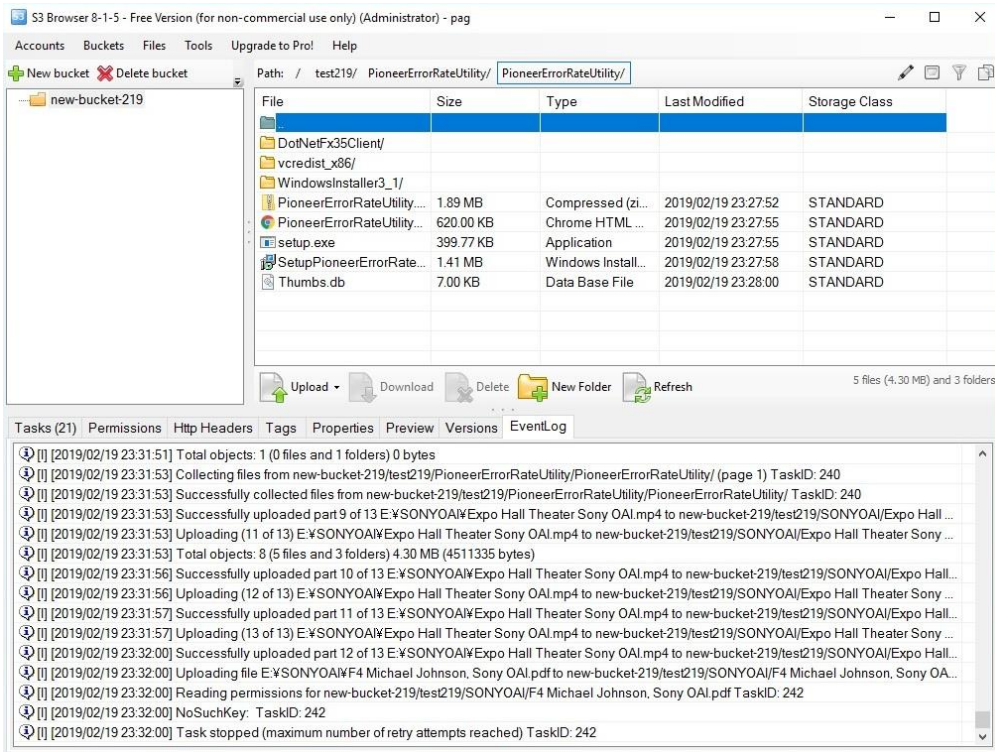

S3 Browser 8-1-5 - Free Version (for non-commercial use only) (Administrator) - pag

Accounts Buckets Files Tools Upgrade to Pro! Help

Path: / test219/ PioneerErrorRateUtility/ PioneerErrorRateUtility/

File	Size	Type	Last Modified	Storage Class
DotNetFx35Client/				
vcredist_x86/				
Windowsinstaller3_1/				
PioneerErrorRateUtility...	1.89 MB	Compressed (zi...	2019/02/19 23:27:52	STANDARD
PioneerErrorRateUtility...	620.00 KB	Chrome HTML ...	2019/02/19 23:27:55	STANDARD
setup.exe	399.77 KB	Application	2019/02/19 23:27:55	STANDARD
SetupPioneerErrorRate...	1.41 MB	Windows Install...	2019/02/19 23:27:58	STANDARD
Thumbs.db	7.00 KB	Data Base File	2019/02/19 23:28:00	STANDARD

Upload Download Delete New Folder Refresh

5 files (4.30 MB) and 3 folders

Tasks (21) Permissions Http Headers Tags Properties Preview Versions EventLog

- [2019/02/19 23:31:51] Total objects: 1 (0 files and 1 folders) 0 bytes
- [2019/02/19 23:31:53] Collecting files from new-bucket-219/test219/PioneerErrorRateUtility/PioneerErrorRateUtility/ (page 1) TaskID: 240
- [2019/02/19 23:31:53] Successfully collected files from new-bucket-219/test219/PioneerErrorRateUtility/PioneerErrorRateUtility/ TaskID: 240
- [2019/02/19 23:31:53] Successfully uploaded part 9 of 13 E:\SONYOAI\Expo Hall Theater Sony OAI.mp4 to new-bucket-219/test219/SONYOAI/Expo Hall ...
- [2019/02/19 23:31:53] Uploading (11 of 13) E:\SONYOAI\Expo Hall Theater Sony OAI.mp4 to new-bucket-219/test219/SONYOAI/Expo Hall Theater Sony ...
- [2019/02/19 23:31:53] Total objects: 8 (5 files and 3 folders) 4.30 MB (4511335 bytes)
- [2019/02/19 23:31:56] Successfully uploaded part 10 of 13 E:\SONYOAI\Expo Hall Theater Sony OAI.mp4 to new-bucket-219/test219/SONYOAI/Expo Hall ...
- [2019/02/19 23:31:56] Uploading (12 of 13) E:\SONYOAI\Expo Hall Theater Sony OAI.mp4 to new-bucket-219/test219/SONYOAI/Expo Hall Theater Sony ...
- [2019/02/19 23:31:57] Successfully uploaded part 11 of 13 E:\SONYOAI\Expo Hall Theater Sony OAI.mp4 to new-bucket-219/test219/SONYOAI/Expo Hall ...
- [2019/02/19 23:31:57] Uploading (13 of 13) E:\SONYOAI\Expo Hall Theater Sony OAI.mp4 to new-bucket-219/test219/SONYOAI/Expo Hall Theater Sony ...
- [2019/02/19 23:32:00] Successfully uploaded part 12 of 13 E:\SONYOAI\Expo Hall Theater Sony OAI.mp4 to new-bucket-219/test219/SONYOAI/Expo Hall ...
- [2019/02/19 23:32:00] Uploading file E:\SONYOAI\F4 Michael Johnson, Sony OAI.pdf to new-bucket-219/test219/SONYOAI/F4 Michael Johnson, Sony OA...
- [2019/02/19 23:32:00] Reading permissions for new-bucket-219/test219/SONYOAI/F4 Michael Johnson, Sony OAI.pdf TaskID: 242
- [2019/02/19 23:32:00] NoSuchKey: TaskID: 242
- [2019/02/19 23:32:00] Task stopped (maximum number of retry attempts reached) TaskID: 242

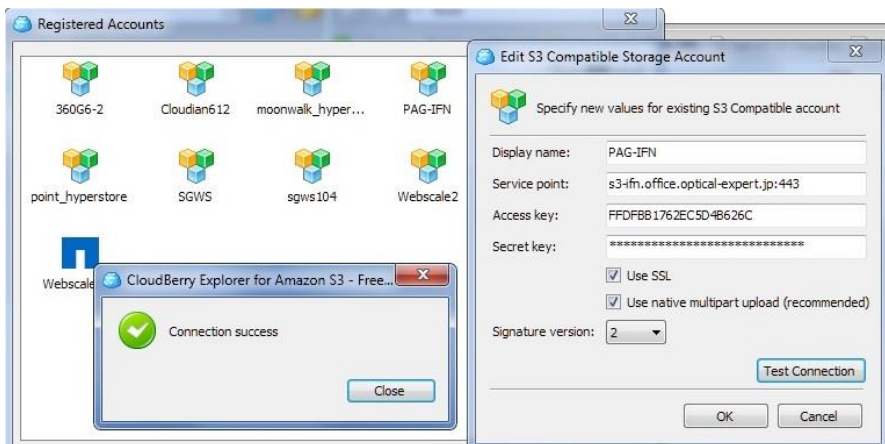

Registered Accounts

360G6-2 Cloudian612 moonwalk\_hyper... PAG-IFN

point\_hyperstore SGWS sgws104 Webscale2

CloudBerry Explorer for Amazon S3 - Free... Connection success

Edit S3 Compatible Storage Account

Specify new values for existing S3 Compatible account

Display name: PAG-IFN

Service point: s3-1fn.office.optical-expert.jp:443

Access key: FFDFFBB1762EC5D4B626C

Secret key: \*\*\*\*\*

Use SSL

Use native multipart upload (recommended)

Signature version: 2

Test Connection

OK Cancel

## S3クライアント(CloudBerry)からPAG/INTノードへの接続

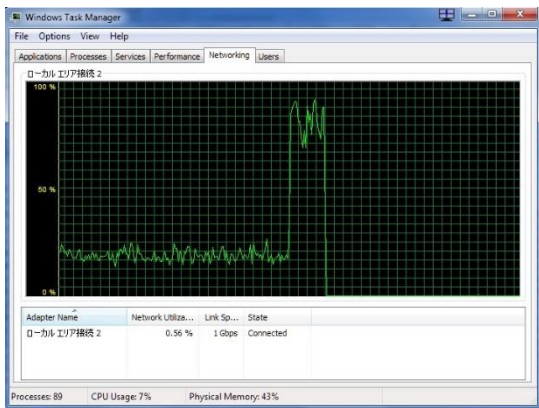
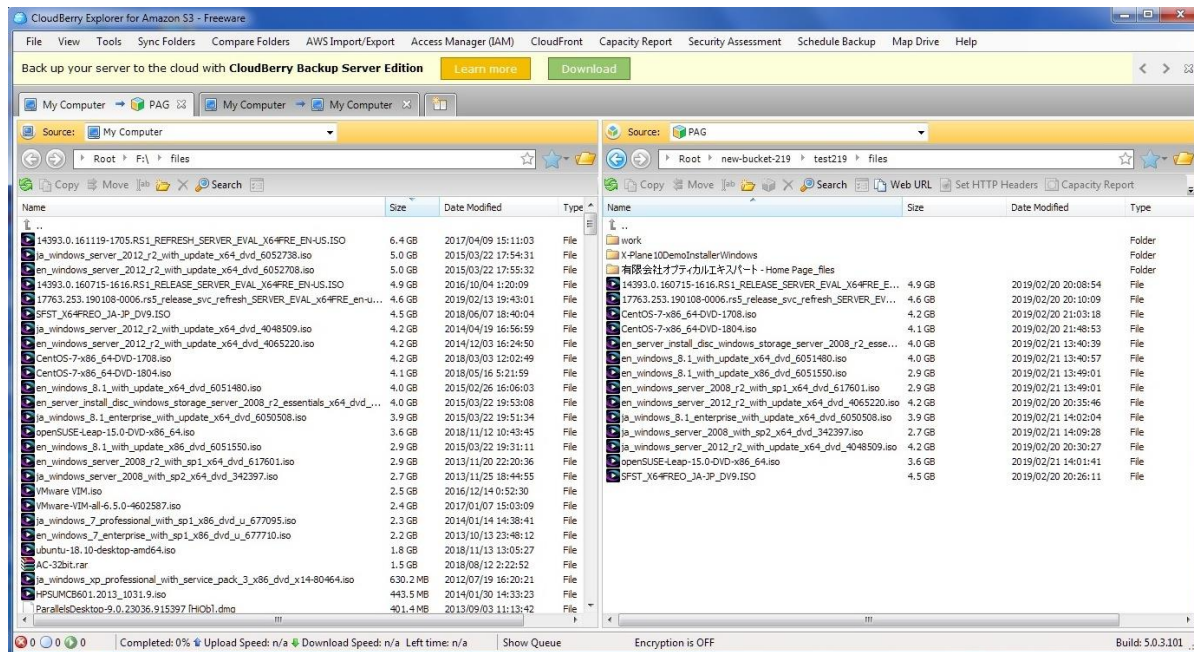



CloudBerry Explorer for Amazon S3 - Freeware screenshot showing a file list of ISO images. The interface includes a menu bar (File, View, Tools, Sync Folders, Compare Folders, AWS Import/Export, Access Manager (IAM), CloudFront, Capacity Report, Security Assessment, Schedule Backup, Map Drive, Help), a toolbar with 'Back up your server to the cloud with CloudBerry Backup Server Edition' buttons, and a file list table.

Name	Size	Date Modified	Type
14933.0.161119-1705.RS1_REFRESH_SERVER_EVAL_X64FRE_EN-US.ISO	6.4 GB	2017/04/09 15:11:03	File
en_windows_server_2012_r2_with_update_x64_dvd_6052738.iso	5.0 GB	2015/03/22 17:54:31	File
en_windows_server_2012_r2_with_update_x64_dvd_6052708.iso	5.0 GB	2015/03/22 17:55:32	File
14933.0.160715-1616.RS1_RELEASE_SERVER_EVAL_X64FRE_EN-US.ISO	4.9 GB	2016/10/04 1:20:09	File
17763.253.190108-0006.rs5_release_svc_refresh_SERVER_EVAL_x64FRE_en-us...	4.6 GB	2019/02/13 19:43:01	File
SFST_X64FREO_JA-JP_DV9.ISO	4.5 GB	2018/06/07 18:40:04	File
ia_windows_server_2012_r2_with_update_x64_dvd_4048509.iso	4.2 GB	2014/04/19 16:56:59	File
en_windows_server_2012_r2_with_update_x64_dvd_4065220.iso	4.2 GB	2014/12/03 16:24:50	File
CentOS-7-x86_64-DVD-1708.iso	4.2 GB	2018/03/03 12:02:49	File
CentOS-7-x86_64-DVD-1804.iso	4.1 GB	2018/05/16 5:21:59	File
en_windows_server_2012_r2_with_update_x64_dvd_6051480.iso	4.0 GB	2015/02/26 16:06:03	File
en_server_install_disc_windows_storage_server_2008_r2_essentials_x64_dvd_...	4.0 GB	2015/03/22 19:53:08	File
ia_windows_server_2012_r2_with_update_x64_dvd_6050508.iso	3.9 GB	2015/03/22 19:51:34	File
openSUSE-Leap-15.0-DVD-x86_64.iso	3.6 GB	2018/11/12 10:43:45	File
ia_windows_server_2012_r2_with_update_x86_dvd_6051550.iso	2.9 GB	2015/03/22 19:33:11	File
en_windows_server_2008_r2_with_sp1_x64_dvd_617601.iso	2.9 GB	2013/11/20 22:20:36	File
ia_windows_server_2008_r2_with_sp2_x64_dvd_342397.iso	2.7 GB	2013/11/25 18:44:55	File
VMware-VMX.iso	2.5 GB	2016/12/14 0:52:30	File
VMware-VMX-all-6.5.0-4602587.iso	2.4 GB	2017/01/07 15:03:09	File
ia_windows_7_professional_with_sp1_x86_dvd_u_677095.iso	2.3 GB	2014/01/14 14:38:41	File
en_windows_7_professional_with_sp1_x86_dvd_u_677710.iso	2.2 GB	2013/10/13 23:48:12	File
ubuntu-18.10-desktop-amd64.iso	1.8 GB	2018/11/13 13:05:27	File
AC-32bit.rar	1.5 GB	2018/08/12 2:22:52	File
ia_windows_xp_professional_with_service_pack_3_x86_dvd_x14-80464.iso	630.2 MB	2012/07/19 16:20:21	File
PSUMCB601.2013_1031.9.iso	443.5 MB	2014/01/30 14:33:23	File
ParallelsDesktop-9.0.23036.915397.fh0b1.dmp	401.4 MB	2013/09/03 11:13:42	File

Completed: 0% Upload Speed: n/a Download Speed: n/a Left time: n/a Show Queue Encryption is OFF Build: 5.0.3.101

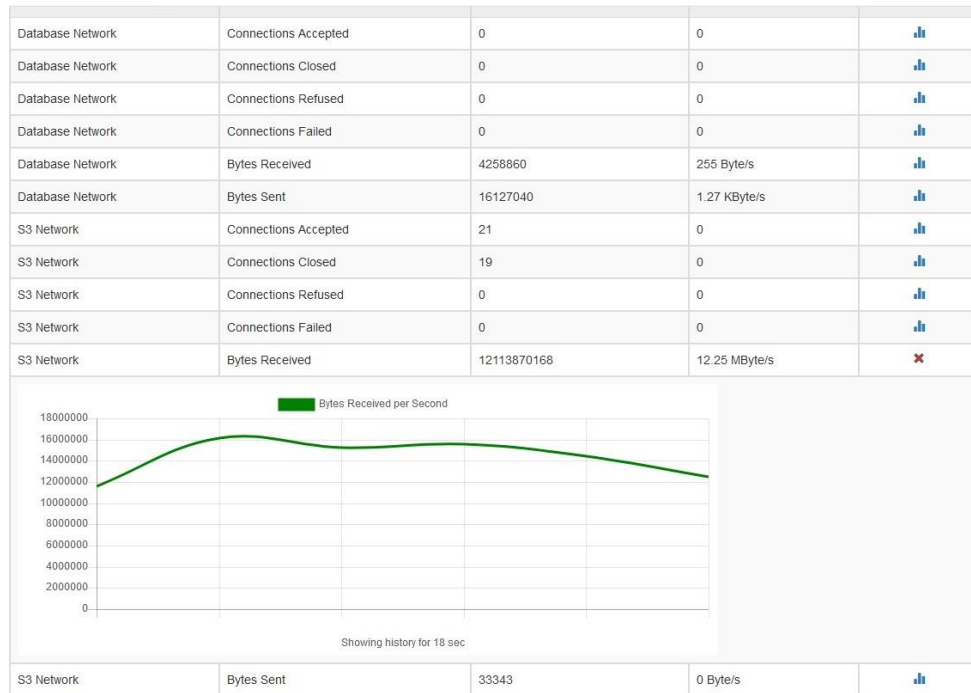
## システムの稼動状況はリアルタイムで表示



PAG管理Webから  
User情報と作成

The screenshot displays the PoINT Archival Gateway user management interface. At the top, there is a navigation bar with the PoINT logo and menu items: Dashboard, System Management, Storage Management, Device Management, Security & Auditing, and Statistics. A secondary bar contains 'Change password for admin' and 'Log off' options. The main content area is divided into two panels: 'Users / point' on the left and 'Users / kadono' on the right. Both panels show a 'Properties' section with various user settings. The 'Users / point' panel includes fields for User Name (point), Enabled (checked), Lockout Enabled (checked), Failed Login Limit (5), Allow S3 Access (checked), S3 Access Key (FFDFBB1762EC5D4B626C), S3 Access Secret (Not displayed, click here to create new), Default Partition (store1 Change partition...), Password Expiration (2018/09/04 22:02:17), Last Successful Login, Failed Logins (0), and Locked Until. An 'Apply' button is at the bottom. Below the properties are 'Roles' and 'Groups' sections, both showing 'No role assigned' and 'No group assigned' respectively. The 'Users / kadono' panel shows similar settings: User Name (kadono), Enabled (checked), Lockout Enabled (checked), Failed Login Limit (5), Allow S3 Access (checked), S3 Access Key (682DE5DC1BC3B8F7F4BE), S3 Access Secret (3jHPd09qleaN8rfr5T2cGiru9dhg), Default Partition (Change partition...), Password Expiration (2018/10/14 18:19:19), Last Successful Login, Failed Logins (0), and Locked Until. An 'Apply' button is also present at the bottom.

**Users / point**

**Properties**

User Name:  [Reset password...](#)

Enabled:

Lockout Enabled:

Failed Login Limit:

Allow S3 Access:

S3 Access Key: FFDFBB1762EC5D4B626C

S3 Access Secret: Not displayed, click here to create new

Default Partition: store1 Change partition...

Password Expiration: 2018/09/04 22:02:17

Last Successful Login:

Failed Logins: 0

Locked Until:

**Roles**

No role assigned.

**Groups**

No group assigned.

**Users / kadono**

**Properties**

User Name:  [Reset password...](#)

Enabled:

Lockout Enabled:

Failed Login Limit:

Allow S3 Access:

S3 Access Key: 682DE5DC1BC3B8F7F4BE

S3 Access Secret: [3jHPd09qleaN8rfr5T2cGiru9dhg](#)  
Please note this secret, it will not be displayed again!

Default Partition: Change partition...

Password Expiration: 2018/10/14 18:19:19

Last Successful Login:

Failed Logins: 0

Locked Until:

# PoINT Archival Gateway

## Object StorageからのS3 Tiering 接続

### Add New Bucket Lifecycle Rule

#### Cloudian HyperStore7.1.3

RULE NAME: tier\_pag    OBJECT PREFIX:     ENABLE TIERING     EXPIRE OBJECTS

**OBJECT TIERING**

**SCHEDULE**

CURRENT VERSION

0 DAYS AFTER LAST ACCESS DATE/TIME     AFTER DATE: Feb-23-2019 12:32 PM

PREVIOUS VERSION

**OBJECT TIERING BUCKET LEVEL SETTING**

**DESTINATION**    **TIERING CREDENTIAL**     Retain Local Copy

Tier to AWS S3    Endpoint: http://s3-pag.office.optical-expert.jp:8080     0 Days before removing local copy

Tier to AWS GLACIER

Tier to Google

Tier to Azure    Access Key: BA77AEB536660C61    Secret Key: 5G0uFlgVD81P×4Zkf

Tier to Spectra

Tier to Custom Endpoint    Bucket Name: new-bucket-219

**LIFECYCLE RULE BUCKET LEVEL SETTING**

Use Creation Date/Time     Use Last Access Time

### NetApp StorageGRID11.2 Cloud Storage Pool

NetApp® StorageGRID®    Help | Root | Sign

Dashboard     Alarms    Nodes    Tenants    ILM    Configuration    Maintenance    Support

**Storage Pools**

A storage pool is a logical group of Storage Nodes or Archive Nodes and is used in ILM rules to determine where object data is stored.

Pool Name	Archive Nodes	Storage Nodes	Used in ILM Rule	Used in EC Profile
All Storage Nodes	0	3	<input checked="" type="checkbox"/>	

Displaying 1 pool.

**Viewing Storage Pool - All Storage Nodes**

Site Name	Archive Nodes	Storage Nodes
All Sites	0	3

**Cloud Storage Pools**

You can add Cloud Storage Pools to ILM rules to store objects outside of the StorageGRID system. A Cloud Storage Pool defines how to access an external bucket where objects will be stored.

Pool Name	URI	Bucket	Access Key ID	Used in ILM Rule
PoINT Archival Gateway	https://s3-pag2.office.optical-expert.jp:8443	new-bucket-321	*****57CA	<input checked="" type="checkbox"/>

Displaying 1 pool.

# PoINT Archival Gateway

## StorageGRID11.2/3 Cloud Storage Poolとして稼動

Cloud Storage Poolとして設定されると  
x-ntap-sgws-cloud-pool-uuidが作成

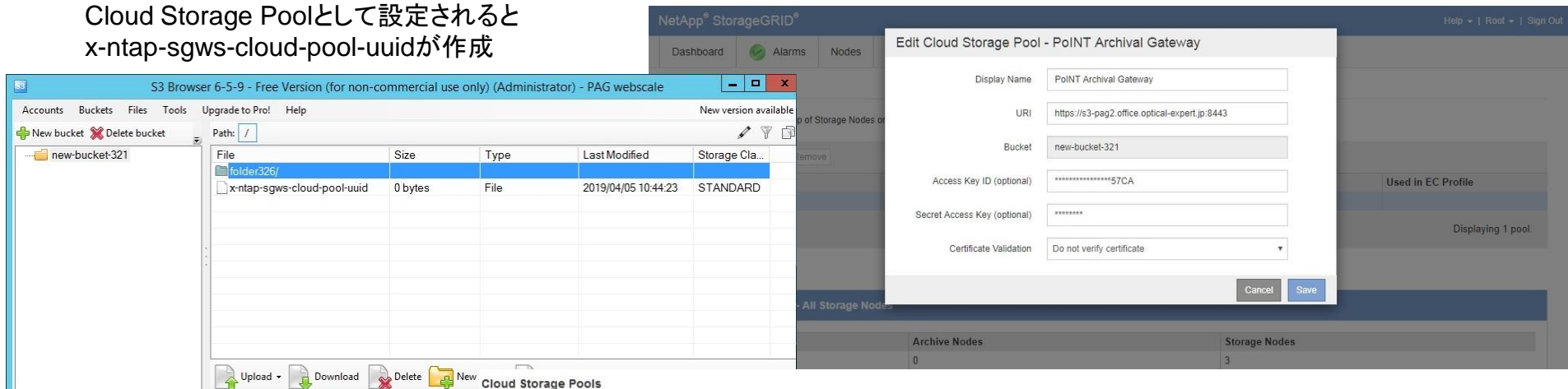

The screenshot shows two overlapping windows. On the left is the S3 Browser interface, displaying a file named 'x-ntap-sgws-cloud-pool-uuid' with a size of 0 bytes and a type of File, created on 2019/04/05 at 10:44:23. On the right is the NetApp StorageGRID 'Edit Cloud Storage Pool' dialog box. The dialog contains the following fields:

- Display Name: PoINT Archival Gateway
- URI: https://s3-pag2.office.optical-expert.jp:8443
- Bucket: new-bucket-321
- Access Key ID (optional): \*\*\*\*\*57CA
- Secret Access Key (optional): \*\*\*\*\*
- Certificate Validation: Do not verify certificate

Buttons for 'Cancel' and 'Save' are visible at the bottom right of the dialog.

You can add Cloud Storage Pools to ILM rules to store objects outside of the StorageGRID system. A Cloud Storage Pool defines how to access the external bucket or container where objects will be stored.

## StorageGrid11.3 Cloud Storage Pool

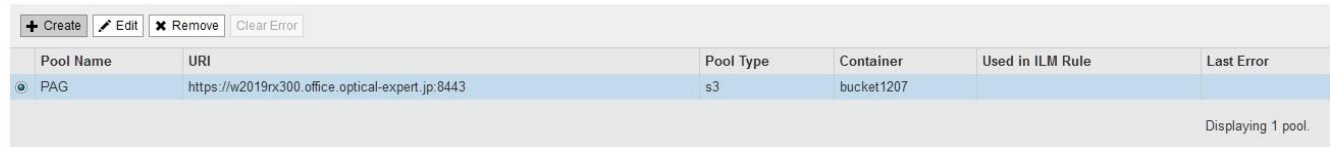

The screenshot shows a table with the following data:

Pool Name	URI	Pool Type	Container	Used in ILM Rule	Last Error
PAG	https://w2019rx300.office.optical-expert.jp:8443	s3	bucket1207		

Buttons for '+ Create', 'Edit', 'Remove', and 'Clear Error' are located above the table. The text 'Displaying 1 pool.' is visible at the bottom right.



## StorageGRID11.3 ILM Rule設定

**Create ILM Rule** Step 2 of 3: Define Placements

Configure placement instructions to specify how you want objects matched by this rule to be stored.

**copy to PAG**  
copy all files to PAG

Reference Time:

**Placements** Sort by start day

From day:  store:  Add Remove

Type:  Location:  Add Pool Copies:  + -

**Retention Diagram** Refresh

Trigger: Day 0

All Storage Nodes

Duration: Forever

Cancel Back Next

## StorageGRID11.3 ILM Policy設定 -1

### Configure ILM Policy

Create a proposed policy by selecting and arranging rules. Then, save the policy and edit it later as required. Click Simulate to verify a saved policy using test objects. When you are ready, click Activate to make this policy the active ILM policy for the grid.

Name

Reason for change

### Rules

Select the rules you want to add to the policy. Drag and drop rows to reorder the rules. Rules are evaluated in order, starting at the top.

+ Select Rules

	Default	Rule Name	Tenant Account	Actions
⊕	<input type="radio"/>	copy to PAG	point (05912549202616796614)	✕
⊕	<input checked="" type="radio"/>	Make 2 Copies	Ignore	✕

Cancel

Save

## StorageGRID11.3 ILM Policy設定 -2

[+ Create Proposed Policy](#)
[📄 Clone](#)
[✎ Edit](#)
[✖ Remove](#)

Policy Name	Policy State	Start Date	End Date
<input checked="" type="radio"/> copy to PAG	Proposed		
<input type="radio"/> Baseline 2 Copies Policy	Active	2019-11-30 01:12:31 JST	

### Viewing Proposed Policy - copy to PAG

Errors in an ILM policy can cause irreparable data loss. Review and simulate the policy carefully before activating.

Review the rules in this policy. If this is a proposed policy, click Simulate to verify the policy and then click Activate to make the policy active.

Reason for change: copy to PAG

Rules are evaluated in order, starting from the top.

Rule Name	Default	Tenant Account
copy to PAG <a href="#">🔗</a>		point (05912549202616796614)
Make 2 Copies <a href="#">🔗</a>	✓	Ignore

[Simulate](#) [Activate](#)

### Simulate ILM Policy - copy to PAG

Simulates the active ILM policy or, if there is a proposed ILM policy, simulates the proposed ILM policy. Use this simulation to test the current configuration of ILM rules and determine whether ILM rules copy and place object data as intended.

Object  [Simulate](#)

### Simulation Results [?](#)

Object	Rule Matched	Previous Match
bucket1130/PoINT-GosObj-01D5AC0047EC0059-CC9B3D537D5E79E5117FC65B529B236878CA805A	copy to PAG <a href="#">🔗</a>	<a href="#">✖</a>

[Finish](#)

## Policy Simulation結果

# PoINT Archival Gateway

## StorageGRID11.2 Grid Manager

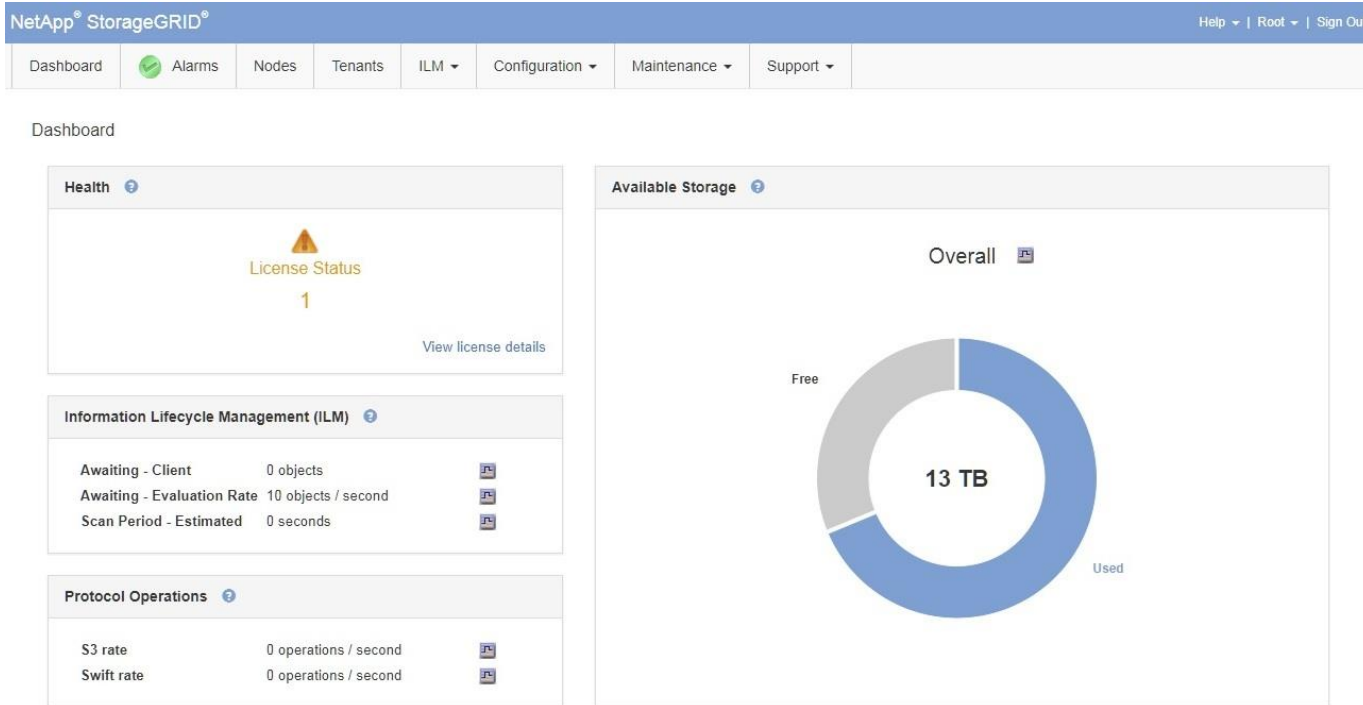

## 記録データの暗号化とリテンション(保管期限)の管理機能

Partitions / PT1

+ Create Object Repository    🔍 Show Protected Volume Arrays

**General Properties**

Name:

Creation Time: 2019/03/02 10:37:22

Modification Time: 2019/04/05 12:09:42

Last Access Time: 2019/04/05 12:09:42

Data Encryption Mode:  ▼  
No encryption  
Encrypt using System Key  
Encrypt using Private Key

リテンションは、バケット単位で設定

Partitions / PT1 / bucket307 / Retention Policy

**Properties**

Creation Time:

Modification Time:

Absolute:

Retention Period:   Days ▼  
Days  
Weeks  
Months  
Years

Auto Destruction:

Apply

## PoINT Archival Gateway Tape Support

- Drives, Loaders, Libraries
  - Native support
  - IBM, HP, Overland, Tandberg, Quantum, Spectra Logic,
  - カートリッジのオフライン管理
- フォーマット
  - 独自仕様のテープフォーマット
  - 最初のBlock0にECMA13 volume labelを記録し開始
  - 異なったサイズのメタデータと元データを保存可能
  - ブロック単位のエラーコード

Storage Element	Barcode of Tray	Volume State	Archival Storage Partition
4096	000002L5	Formatted ▾	test1
4097	000004L5	Unknown ▾	
4098	000005L5	Unknown ▾	
4099	000010L5	Unknown ▾	
4100	000008L5	Unknown ▾	
4108	000006L5	Unknown ▾	
4109	000009L5	Unknown ▾	
4110	000007L5	Unknown ▾	
4111	000001L5	Unknown ▾	

## Erasur Codingで平行に LTOドライブでデータ記録 3/4では、3データ、1パリティ

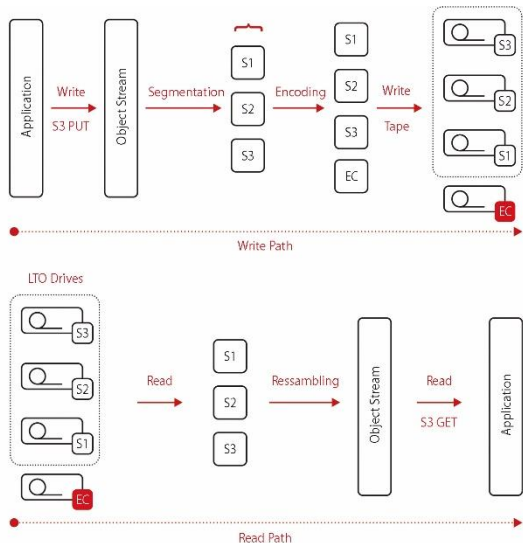

### Device Related Properties

Device Type: Tape Library

Erasure Code Rate: 1/1 1/1 1/2 2/2 1/3 2/3 3/3 1/4 2/4 3/4 4/4

Media Allocation Strategy: ing

Media Pre-Allocation Threshold: medium

Media Parallelism: medium

Device Allocation Source Priority: v

Device Allocation Source Limit: <No Limit>

<No Limit>

Tape Library

Apply

## ライブラリーとカートリッジの管理単位

### •Archival Storage Partition / ASP

LTOライブラリーのスロットをストレージの管理単位として割り当てる。

さらに、サイズ、イレージャーコーディング(EC)のレベル、暗号化、自動拡張、リード/ライトの優先権を設定

### •Protected Volume Array / PVA

LTOカートリッジが入っているLTOライブラリーASPへのスロットの割り当てやデータの保護レベルを割り当て

### •Object Repository / OR(Bucket)

AWS S3サーバーでのBucketに相当する。使用するArchival Storage Partitionの指定

オブジェクトのリテンション(保管期限)の設定、ユーザアクセス設定(User, Group, Read Only,,)



## Partition / Object Repositories / Protected Volume Arrays

Partitions / 1213\_1

+ Create Object Repository    🔍 Show Protected Volume Arrays

**General Properties**

Name:

Creation Time: 2019/12/13 12:21:48

Modification Time: 2020/01/19 0:03:43

Last Access Time: 2020/02/13 15:13:13

Data Encryption Mode:

---

**Device Related Properties**

Device Class:

Erasure Code Rate:

Media Allocation Strategy:

Media Pre-Allocation Threshold:

Media Parallelism:

Media Allocation Order:

Media Allocation Restriction:

Object Repositories

Filter:

Name	Delete
<a href="#">bucket1220-mda0nze0mdixntc2ode0mtg1mzu2</a>	<input type="button" value="🗑"/>
<a href="#">hpt1220</a>	<input type="button" value="🗑"/>
<a href="#">pag_lto5</a>	<input type="button" value="🗑"/>

Partitions / 1213\_1 / Protected Volume Arrays

Filter:

PVA	Device	Storage Element	Barcode	Volume State
1+	<a href="#">Tape Library</a>	0	000004L5	Formatted

Code Rate: 1/1  
Encryption: Off

## システムの稼動状況の表示

### Statistics Information

Select Source:

Expand All

Filter:

Source	Type	Current Count	Units/Sec	Chart
Drive 1	Objects Read	0	0	
Drive 1	Objects Written	1	0	
Drive 1	Bytes Read	131072	0 Byte/s	
Drive 1	Bytes Written	4225630208	88.38 MByte/s	

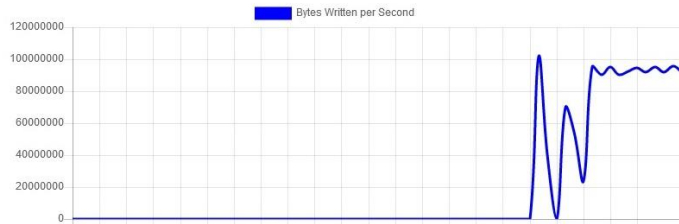

Showing history for 3 min 27 sec

Database Network	Connections Accepted	0	0	
Database Network	Connections Closed	0	0	
Database Network	Connections Refused	0	0	
Database Network	Connections Failed	0	0	
Database Network	Bytes Received	4258860	255 Byte/s	
Database Network	Bytes Sent	16127040	1.27 KByte/s	
S3 Network	Connections Accepted	21	0	
S3 Network	Connections Closed	19	0	
S3 Network	Connections Refused	0	0	
S3 Network	Connections Failed	0	0	
S3 Network	Bytes Received	12113870168	12.25 MByte/s	

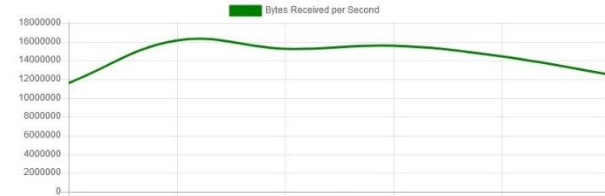

Showing history for 18 sec

S3 Network	Bytes Sent	33343	0 Byte/s	
------------	------------	-------	----------	--

## System Cluster Nodes / Log for IFN 1

Download (111.19 KiB/te)

↑ Line ↑ Page ↑ Top

↓ Line ↓ Page ↓ End ↻

2019/04/09 14:02:02:986	Number of logical CPUs: 16
2019/04/09 14:02:03:117	Starting data communication services ...
2019/04/09 14:02:03:120	Database communication client is connected to 192.168.1.230:4000
2019/04/09 14:02:03:120	-----
2019/04/09 14:02:03:120	PoINT Archival Gateway services are running.
2019/04/09 14:02:03:120	-----
2019/04/09 14:02:03:120	Data communication services are running.
2019/04/09 14:02:03:204	Interface communication server failed to listen to 192.168.1.230:4000, network address is
2019/04/09 14:02:03:303	Starting device control services ...
2019/04/09 14:02:03:474	Device control services are running.
2019/04/09 14:02:03:474	Starting metadata caching services ...
2019/04/09 14:02:03:474	Metadata caching services are running.
2019/04/09 14:02:03:474	Starting S3 REST API services ...
2019/04/09 14:02:03:475	S3 REST API is using FQDN "s3-pag2.office.optical-expert.jp"
2019/04/09 14:02:03:480	Drives: IBM ULT3580-HH5 revision F991 connected
2019/04/09 14:02:03:480	Device: IBM 3573-TL serial number 00X2U78Z0863_LL0 (1/23 drive/volume groups) is oper
2019/04/09 14:02:03:516	S3 REST API service is listening to 192.168.1.231:9080
2019/04/09 14:02:03:516	S3 REST API service is listening to 192.168.1.231:8443
2019/04/09 14:02:03:519	S3 REST API services are running.
2019/04/09 14:02:03:707	Device: IBM 3573-TL serial number 00X2U78Z0863_LL0: Drive group 1: ready and operabl

↑ Line ↑ Page ↑ Top

↓ Line ↓ Page ↓ End ↻

## System Cluster Nodes / Log for DBN 1

Download (219.11 KiB/te)

↑ Line ↑ Page ↑ Top

↓ Line ↓ Page ↓ End ↻

Display 20 lines per page

2019/04/09 13:58:13:015	-----
2019/04/09 13:58:13:015	PoINT Archival Gateway services are running.
2019/04/09 13:58:13:015	-----
2019/04/09 13:58:13:015	Adding shares for database directories ...
2019/04/09 13:58:13:017	Shares for database directories have successfully been added.
2019/04/09 13:58:13:043	Current license grants temporary use until 2019/04/21.
2019/04/09 13:58:13:043	Starting user management services ...
2019/04/09 13:58:13:044	Database 'C:\Database\HDD\pag-users.db' has been opened.
2019/04/09 13:58:13:047	User management services are running.
2019/04/09 13:58:13:047	Starting metadata caching services ...
2019/04/09 13:58:13:048	Database 'C:\Database\HDD\pag-asp.db' has been opened.
2019/04/09 13:58:13:189	Metadata caching services are running.
2019/04/09 13:58:13:189	Starting device control services ...
2019/04/09 13:58:13:191	Database 'C:\Database\HDD\pag-devices.db' has been opened.
2019/04/09 13:58:13:193	Device control services are running.
2019/04/09 13:58:13:193	Devices: scanning for connected and supported media changer devices ...
2019/04/09 13:58:13:472	Devices: IBM 3573-TL revision F.11 serial number 00X2U78Z0863_LL0 has been detected and updated
2019/04/09 13:58:13:472	Devices: Scan process has successfully been completed.
2019/04/09 13:58:13:473	Database 'C:\Database\HDD\pag-tape-mo.db' has been opened.
2019/04/09 13:58:13:754	Devices: IBM 3573-TL revision F.11 serial number 00X2U78Z0863_LL0 has successfully been started

↑ Line ↑ Page ↑ Top

↓ Line ↓ Page ↓ End ↻

## ライセンスは、使用するLTOライブラリーのスロット数

- LTOドライブは4台単位
  - メディアのミラーリング
  - メディアのオフライン管理
  - ユーザー管理、DB自動バック機能
- ライセンスの単位
  - 12スロット
  - 32スロット
  - 48スロット
  - 96スロット
  - 280スロット
  - 560スロット

Software License	
Serial Number:	7000100006180503
Configuration Key:	AVKBR-H6X3K-1BTAX
Product Key:	c4e3c02a-e715
License Key:	<input type="text" value="C48Y-CE9A-15XB-7"/> <input type="button" value="Apply"/>
License Period:	Expires on 2019/04/22 8:59:59
License Status:	Valid
Copyright:	© PoINT Software & Systems GmbH 1994-2019 All rights reserved

[www.point.de](http://www.point.de)

[www.optical-expert.jp/index2.html](http://www.optical-expert.jp/index2.html)